

3 OSOLON[®] 80 SSL Power Linear Board Colours

ILR-ON03-####-SC201-WIR200.

Product Overview

The Power ON03 from ILS is now the smallest linear strip in the ILS linear portfolio. Each ON03 contains 3 OSOLON SSL 80 ThinGan (UX:3) LEDs. OSOLON[®] SSL can be driven from 100mA-1000mA depending on the colour temperature while OSRAM's latest power chip technology remains efficient even at the highest drive currents. A low thermal resistance of 7 K/W ensures cool running and a highly efficient product. MiniFloods are compact, powerful LED light sources built on aluminium substrates for optimal thermal management.

Available with 200mm wires as standard.



Applications

- General Lighting
- Decorative Lighting
- Task Lighting
- Retail and Entertainment Lighting
- Flood Lighting

Technical Features

- Power ON03 contain OSRAM Opto Semi OSOLON[®] SSL 80 LEDs with high efficacy
- Up to 50,000 Hour lifetime to 70% of original brightness
- Mounting holes using M3 screws allows easy installation
- Size 25mm L x 15mm W x 3.9mm H
- Power ON03s can be linked together to produce longer chains.
- Current range 100mA to 1000mA depending on colour temperature*

*This datasheet should be read in conjunction with the relevant OSRAM Opto Semiconductors data on the LED used

Important Information and Precautions

- The Power ON03's LEDs, when powered up, is very bright. Thus it is advised that you do not look directly at it. Turn the Power ON03 away from you and do not shine into the eyes of others.
- Do not operate Power ON03 with a Power Supply with unlimited current. Connection to constant voltage Power
- Supplies that are not current limited may cause the Power ON03 to consume current above the specified maximum and cause failure or irreparable damage.
- ON03's, when operated, can reach high temperatures thus there is risk of injury if they are touched.
- DO NOT HOT PLUG ON LED SIDE OF POWER SUPPLY.
- DO NOT TOUCH or PUSH on the LED as this can cause irreparable damage.

Product Options

ILS PART NUMBER	Colour	Typical Wattage § at 350mA	Forward Voltage	Flux † at 350mA	Radiance Angle	Relevant OSRAM LED Data
ILR-ON03-DEBL-SC211-WIR200.	Deep Blue (455nm)	3.27watts	8.1-10.5volts	>1890mW	80° (±40°)	LDCQ7P
ILR-ON03-BLUE-SC211-WIR200.	Blue (470nm)	3.27watts	8.1-10.5volts	>213lms	80° (±40°)	
ILR-ON03-TRGR-SC211-WIR200.	True Green (528nm)	3.27watts	8.1-10.5volts	>336lms	80° (±40°)	LTCP7P
ILR-ON03-YELL-SC211-WIR200.	Yellow (590nm)	2.43watts	6-7.8 volts	>213lms	80° (±40°)	LYCP7P
ILR-ON03-RDOR-SC211-WIR200.	Red Orange (617nm)	2.31 watts	6-7.8 volts	>270lms	80° (±40°)	LACP7P
ILR-ON03-RED1-SC211-WIR200.	Red (625nm)	2.73watts	6-7.8 volts	>213lms	80° (±40°)	LRCP7P
ILR-ON03-HYRE-SC211-WIR200.	Hyper Red (656nm)	2.25watts	6-7.8 volts	>1200mW	80° (±40°)	LHCP7P
ILR-ON03-FRED-SC211-WIR200.	Far Red (730nm)	1.95watts	4.8-6.9 volts	>603mW	80° (±40°)	GFC-S8PM1.24

* Due to the special conditions of the manufacturing processes of LEDs, the typical data of technical parameters can only reflect statistical figures and do not necessarily correspond to the actual parameters of each single product which could differ from the typical data.

§ Tolerance +/- 10%

† Measured with 20mS 350mA pulse at 25 °c

Minimum and Maximum Ratings

Minimum and Maximum Ratings

ILS PART NUMBER	Operating Temperature at Tc-Point [°C]*	Storage Temperature [°C]*	Forward Current per chip [mA]*	Reverse Voltage [Vdc] *
ILR-ON03-DEBL-SC211-WIR200.	70°C max	- 40 to 110 °C	800mA max	not designed for reverse voltage
ILR-ON03-BLUE-SC211-WIR200.	70°C max	- 40 to 110 °C	800mA max	not designed for reverse voltage
ILR-ON03-TRGR-SC211-WIR200.	70°C max	- 40 to 110 °C	800mA max	not designed for reverse voltage
ILR-ON03-YELL-SC211-WIR200.	70°C max	- 40 to 110 °C	800mA max	not designed for reverse voltage
ILR-ON03-RDOR-SC211-WIR200.	70°C max	- 40 to 110 °C	800mA max	not designed for reverse voltage
ILR-ON03-RED1-SC211-WIR200.	70°C max	- 40 to 110 °C	1000mA max	not designed for reverse voltage
ILR-ON03-HYRE-SC211-WIR200.	70°C max	- 40 to 110 °C	1000mA max	not designed for reverse voltage
ILR-ON03-FRED-SC211-WIR200.	70°C max	- 40 to 110 °C	1000mA max	not designed for reverse voltage

* Exceeding maximum ratings for operating and storage temperature will reduce expected life time or destroy the LED module. Exceeding maximum ratings for operating voltage will cause hazardous overload and will likely destroy the LED module. The temperature of the LED module must be measured at the Tc-Point according to EN60598-1 in a thermally constant status with a temperature sensor or a temperature sensitive label.

Radiation of single LED

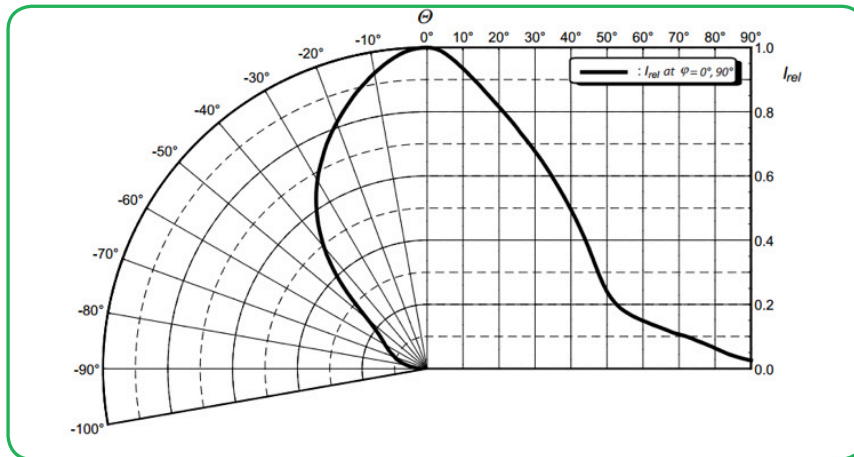

Technical Drawing with cables (mm)

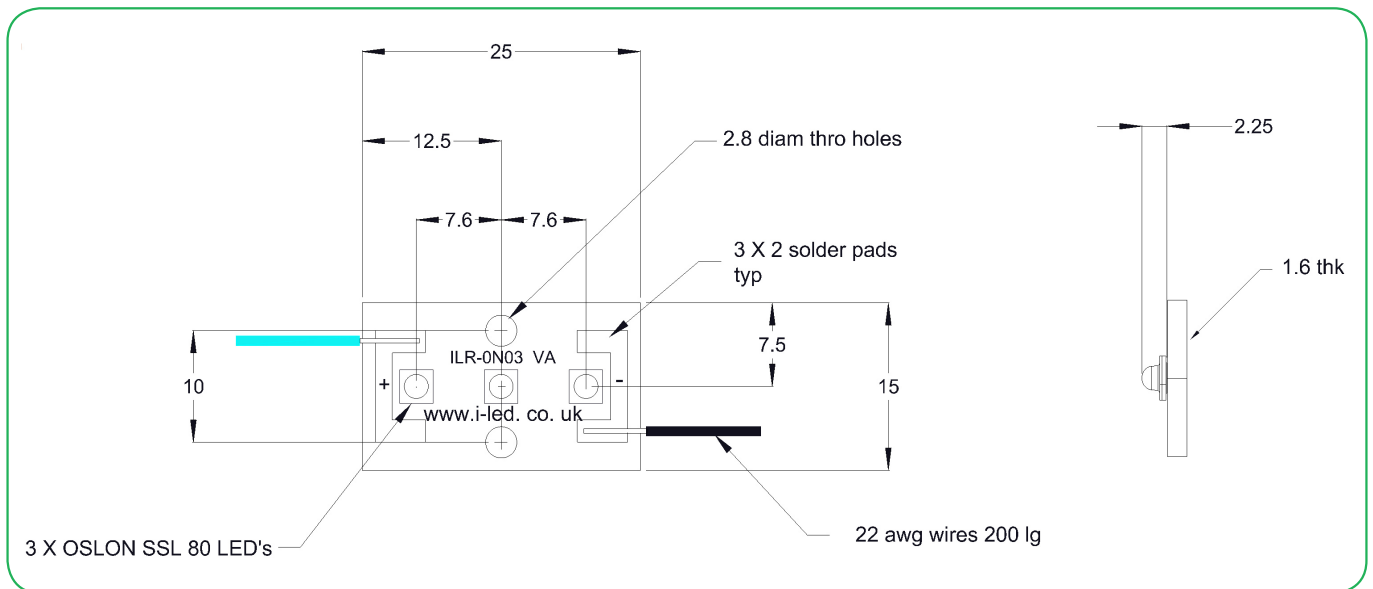

3D drawing files are available on request from ILS. Please call or email

3 OSLON® 80 Lens and Reflector Options

LEDiL precision-engineered Lenses and Reflectors allow for rapid deployment of all types of light fixtures, including street lights, wall-wash, high-bay, sconces, emergency beacons, parking garage/low-bay, MR and AR down lights, and dock lights. Precision-engineered for maximum efficiency and durability, LEDiL Lenses and Reflectors are released alongside the latest product releases from our LED suppliers. You select the best LED for the application; choose LEDiL and you're selecting the best optical solution as well.



Currently there are no Lens or Reflector options for the OSLON® 3 range of products.

3 OSLON® 80 Micro Linear Heat Sink Option

ILS has a series of Aluminium Alloy Heat Sinks to be used with our standard range of PowerStars, PowerClusters and PowerLinear Engines. These Heat Sinks are supplied with fixing screws for the light engine and for fixing to a base plate. They also come with Thermal Interface Material (TIM) attached to the top surface. Available in Black, Red, Silver and Blue colour variants. More versions will be introduced over the coming months and we are also happy to manufacture custom Heat Sinks to your request.

	Operates under the recommended ILS junction temperature
	Operates under the recommended LED maximum junction temperature
	Not suitable for use
N/A	Heat Sink not designed for use with this product





Currently there are no Heat Sink options for the OSLON® 3+ range of products.

3 OSLO[®] 80 Power ON03 Power Supply Options

ILS has a comprehensive range of standard Power Supplies. The table below shows the total number of ILS products each Power Supply can drive.

Additional Power Supplies are being introduced so please call us or check our website for the latest offering.

ILS Driver Part No.	Rating	Current	3 OSLO [®] Power ON03	
IZC015-005F-0067C-QA	5	150mA	3	
IZC035-005F-0067C-QA	5	350mA	1	
IZC035-008F-5065C-SA	8	350mA	1-4	
IZC070-008F-5065C-SA	8	700mA	1	
IZC035-012F-8000C-SA	12	350mA	1-3	
IZC035-017F-0067A-SA	17	350mA	1-5	
IZC035-018T-9500A-SA	18	350mA dim	2-5	
IZC050-018T-9500A-SA	18	500mA dim	1-4	
IZC070-018T-9500A-SA	18	700mA dim	1-2	
IZC035-035F-9067C-QA	35	350mA	5-8	
IZC070-035F-0067C-SA	35	700mA	1-5	
IZC105-035F-9067C-QA	35	1050mA	2-3	
IZC045-040A-9266C-SA	40	450mA dim	4-9	

ILS Driver Part No.	Rating	Current	3 OSLO [®] Power ON03	
IZC105-040A-0067C-QA	40	1050mA dim	3-4	
IZC070-050A-9267C-SA	50	700mA dim	3-8	
IZC050-060F-9067C-QA	60	500mA	5-12	
IZC105-060F-9067C-QA	60	1050mA	3-4	
IZC070-075A-9267C-SA	75	700mA	6-12	

Thermal Interface Material Options

ILS have produced a range of High-performance, cost effective Thermal Interface Materials to match perfectly their standard products.

Our product fills the air pockets between the two surfaces, forming a continuous layer to conduct heat away from the LED to the Heat Sink.

ILS offer our TIM in three options – double sided adhesive, single sided adhesive and non adhesive.

Assembly Information

- In order to optimise the thermal management, the metal surface needs to be clean (dirt and oil free) and planar for the best contact with the LED module. A thermal grease or heat transfer material is highly recommended.

Safety Information

- The LED module itself and all its components must not be mechanically stressed.
- Assembly must not damage or destroy conducting paths on the circuit board.
- The mounting of the module is carried out by attaching it at the mounting holes. Metal mounting screws must be insulated with synthetic washers to prevent circuit board damage and possible short circuiting.
- To avoid mechanical damage to the connecting cables, the boards should be attached securely to the intended substrate. Heavy vibration should be avoided.
- Observe correct polarity!
- Depending on the product, incorrect polarity will lead to emission of red or no light. The module can be destroyed! Pay attention to standard ESD precautions when installing the Petunia.
- The Micro Linear Strip, as manufactured, have no conformal coating and therefore offer no inherent protection against corrosion.
- Damage by corrosion will not be accepted as a materials defect claim. It is the user's responsibility to provide suitable protection against corrosive agents such as moisture and condensation and other harmful elements.

- For outdoor usage, housing is definitely required to protect the board against environmental influences. The design of the housing must correspond to the IP standards in the application. It is also the responsibility of the user to ensure any housing or modifications keep the Tc junction temperature to within stated ranges.
- To also ease the luminaire/installation approval, electronic control gear for LED or LED modules should carry the CE mark and be ENEC certified. In Europe the declarations of conformity must include the following standards: CE: EC 61374-2-13, EN 55015, IEC 61547 and IEC 61000-3-2 - ENEC: 61374-2-13 and IEC/EN 62384.
- The evaluation of eye safety occurs according to the standard IEC 62471:2006 ("photobiological safety of lamps and lamp systems"). Within the risk grouping system of this CIE standard, the LED specified in this data sheet falls into the class moderate risk" (exposure time 0.25s). Under real circumstances (for exposure time, eye pupils, observation distance), it is assumed that no endangerment to the eye exists from these devices. As a matter of principle, however, it should be mentioned that intense light sources have a high secondary exposure potential due to their blinding effect. As is also true when viewing other bright light sources (e.g. headlights), temporary reduction in visual acuity and afterimages can occur, leading to irritation, annoyance, visual impairment and even accidents, depending on the situation.

For further information please contact ILS

The values contained in this data sheet can change due to technical innovations. Any such changes will be made without separate notification.