

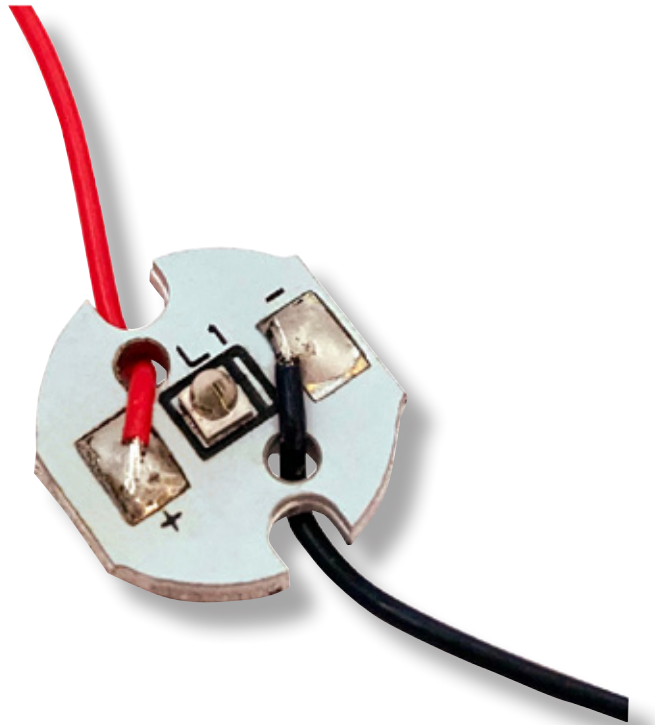

OSLON® IR P1616 Lens 1 MicroOSLON

ILM-IQ01-xxSL-SC201-WIR200.

At the heart of each MicroOSLON is an OSLON® IR P1616 Lens LED. OSLON® IR P1616 Lens can be driven up to 500mA while OSRAM's latest power chip technology remains efficient even at the highest drive currents. The small package with an integrated lens allows superior, compact arrangements of very high power density. A low thermal resistance of 8.1K/W ensures cool running and a highly efficient product. MicroOSLONs are compact, powerful LED light sources built on aluminium substrates for optimal thermal management. Available with 200mm wires as standard.



CONTENTS

Applications	page 2	Secondary Optics Options	page 6
Technical Features	page 2	Heatsink Options	page 6
Product Options	page 3	Power Supply Options	page 7
Minimum and Maximum Ratings	page 3	Thermal Interface Material Options	page 7
Accessories	page 4	Assembly Information	page 8
Technical Drawings	page 5	Important Information and Precautions	page 8
LED Radiation Diagram	page 5	Safety Information	page 9

APPLICATIONS

- » Access Control
- » Eye Tracking
- » CCTV
- » Safety and Security
- » Gesture Recognition
- » Machine Vision

TECHNICAL FEATURES

LED Family	OSLON® P1616 Lens
Lifetime	Up to 100,000 hour lifetime to 70% of original brightness
Dimensions	(L x W x H) 11 x 11 x 3.3mm
Wiring	Available with 200mm connecting wires
Secondary Optics	A secondary optic can be fitted. Suitable options on page 6 or visit our website for a full range
Heatsinks	Required over 350mA. Suitable options on page 8 or visit our website for a full range
Power Supply	4-75W dimming and non-dimming. Suitable options on page 9 or visit our website for a full range
Chain	MicroOSLONs can be linked together to produce longer chains
Current Range	10 to 500mA
Thermal Resistance	8.1K/W

PRODUCT OPTIONS

ILS Part Number	IR centroid wavelength	Radiant intensity IF = 1 A , tp = 10 ms§	Forward Voltage †	Radiance Angle	Relevant OSRAM LED Data
ILM-IQ01-85SL-SC201-WIR200.	850nm	680mW/sr	3.2-3.60V	70° (±35°)	SFH4171S
ILM-IQ01-94SL-SC201-WIR200.	940nm	680mW/sr	2.95-3.3V	70° (±35°)	SFH4181S

Due to the special conditions of the manufacturing processes of LEDs, the typical data of technical parameters can only reflect statistical figures and do not necessarily correspond to the actual parameters of each single product which could differ from the typical data.

§ Tolerance +/- 10%

† Measured with 10mS 1A pulse at 25 °C

MINIMUM AND MAXIMUM RATINGS

ILS Part Number	Operating Temperature at Tc-Point [° C]	Storage Temperature [° C]	Forward Current per Chip [mA]	Reverse Voltage [Vdc]
ILM-IQ01-85SL-SC201-WIR200.	-40 °C ~ 105 °C	-40 °C ~ 105 °C	10-500mA	5V
ILM-IQ01-94SL-SC201-WIR200.	-40 °C ~ 105 °C	-40 °C ~ 105 °C	10-500mA	5V

Exceeding maximum ratings for operating and storage temperature will reduce expected life time or destroy the LED module.

Exceeding maximum ratings for operating voltage will cause hazardous overload and will likely destroy the LED module.

The temperature of the LED module must be measured at the Tc-Point according to EN60598-1 in a thermally constant status with a temperature sensor or a temperature sensitive label.

ACCESSORIES

Secondary Optics Options



LEDiL precision-engineered lenses and reflectors allow for rapid deployment of all types of light fixtures, including street lights, wall-wash, high-bay, sconces, emergency beacons, parking garage/low-bay, MR and AR downlights, and dock lights. Precision-engineered for maximum efficiency and durability, LEDiL lenses and reflectors are released alongside the latest products from our LED suppliers. Suitable options on [page 6](#) or visit [our website](#) for a full range.

Heatsinks



ILS has a series of aluminium alloy heatsinks to be used with our standard range of PowerStars and PowerClusters. These heatsinks are supplied with fixing screws for the light engine and for fixing to a base plate. They also come with thermal interface material (TIM) attached to the top surface. Suitable options on [page 6](#) or visit [our website](#) for a full range.

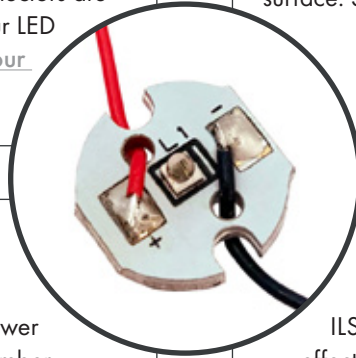

Power Supplies

ILS has a comprehensive range of standard power supplies. The table below shows the total number of ILS products each power supply can drive. Additional power supplies are being introduced so please call us or [check our website](#) for the latest offering. Suitable options on [page 7](#)



Thermal Interface Material (TIM)

ILS has produced a range of high-performance, cost effective thermal interface materials to perfectly match their standard products. Our product fills the air pockets between the two surfaces, forming a continuous layer to conduct heat away from the LED to the heatsink. ILS offers TIM in three options – double sided adhesive, single sided adhesive and non adhesive. Suitable options on [page 7](#) or visit [our website](#) for a full range.



TECHNICAL DRAWINGS (MM)

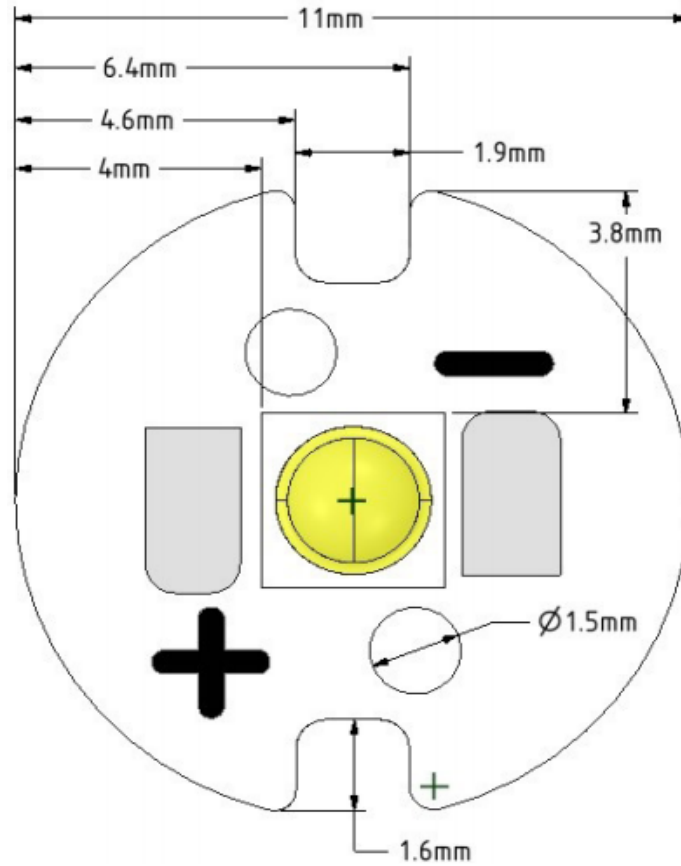

RADIATION OF SINGLE LED

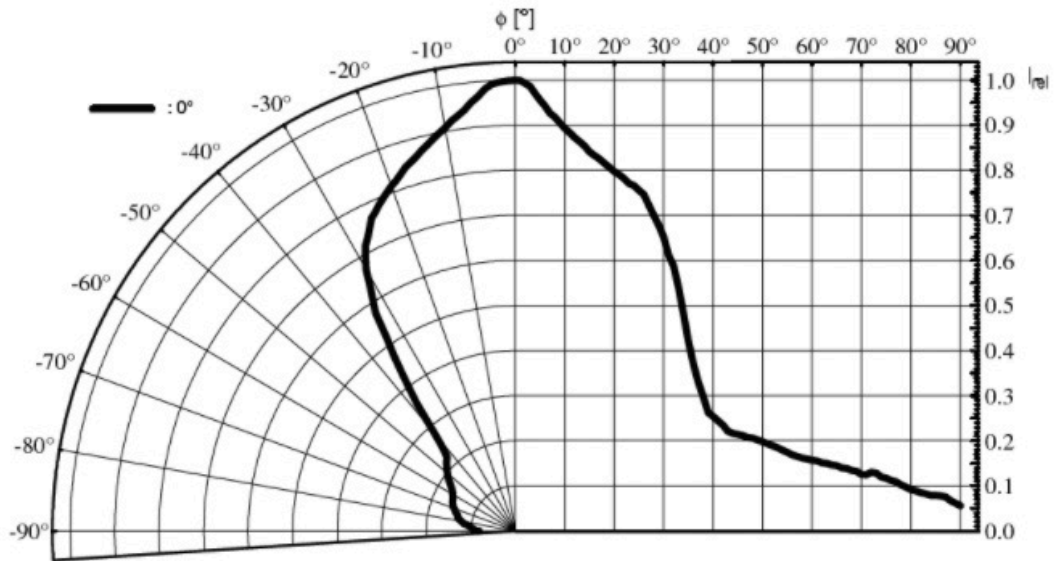

SECONDARY OPTICS OPTIONS

Part Number	Beam	Size	Height	Family	FWHM	Material	Colour	Fastening
FP16607_LISA3CSP-RS-PIN	Spot	10mm	7.2mm	Lisa3CSP	16°	PMMA	Black	Glue + Pin
FP10995_LISA2-M-PIN	Medium	9.9mm	6.8mm	Lisa2	14°	PMMA	Black	Glue + Pin
FP11125_LISA2-O-PIN	Oval	9.9mm	6.8mm	Lisa2	46+16°	PMMA	Black	Glue + Pin
FP11851_LISA2-O-90-PIN	Oval	9.9mm	6.8mm	Lisa2	13+45°	PMMA	Black	Glue + Pin
FP11429_LISA2-WWW-PIN	Wide	9.9mm	6.8mm	Lisa2	58°	PMMA	Black	Glue + Pin
FP10996_LISA2-W-PIN	Wide	9.9mm	6.8mm	Lisa2	25°	PMMA	Black	Glue + Pin
FP10997_LISA2-WW-PIN	Wide	9.9mm	6.8mm	Lisa2	25°	PMMA	Black	Glue + Pin
FP11055_LISA2-RS-PIN	Spot	9.9mm	6.8mm	Lisa2	9°	PMMA	Black	Glue + Pin

[Click here to visit our website for our latest range](#)

HEATSINK OPTIONS





ILS Product	100mA	350mA	500mA
No Heatsink, in free air			

KEY

	Operates under the recommended ILS junction temperature
	Operates under the recommended LED maximum junction temperature
	Not suitable for use
	Heatsink not designed for use with this product

[Click here to visit our website for our latest range](#)

POWER SUPPLY OPTIONS

Image	Driver Part Number	Rating Watts	Current	MicroOSLON per Driver	Dimming
	IZC035-004F-4065C-SAL	4W	350mA	2-3	No
	IZC070-004F-4065C-SAL	4W	700mA	1	No
	IZC035-008F-5065C-SA	8W	350mA	2-10	No
	IZC070-008F-5065C-SA	8W	700mA	2-3	No
	OTi DALI 10/220...240/700 NFC I	10W	150-700mA	1-12	DALI
	ILA-1CH-LED-TESTER-PREC-01	16.8	10-700mA	1-6	Yes
	IZCVAR-040M-9020C-SAL	40W	350mA, 500mA, 600mA, 700mA, 900mA, 1050mA	350mA 1-27, 500mA 1-22, 600mA 1-18, 700mA 1-15, 900mA 1-12, 1050mA 1-11	0-10V, PWM and Resistance
	OT 50/120...277/800 2DIMLT2 P	50W	350-800mA	11-31	1-10V
	IT-FIT-4/220-240/400-CS-I	4W	100-400mA	1-2	No
	IT-FIT-7/220-240/700-CS-I	7W	350-700mA	1-3	No
	IT-FIT-11/220-240/500-CS-I	11W	350-500mA	4-5	No
	IT-FIT-15/220-240/700-CS-I	11W	550-700mA	4-5	No

[Click here to visit our website for our latest range](#)

THERMAL INTERFACE MATERIAL OPTIONS

Double Sided Adhesive

ILA-TIM-MICRO-2A

Other sizes are available, including customised parts

[Click here to visit our website for our latest range](#)

ASSEMBLY INFORMATION

- » The mounting of the MircoOSLON has to be on a metal heatsink.
- » In order to optimise the thermal management, the metal surface needs to be clean (dirt and oil free) and planar for the best contact with the LED module. A thermal grease or heat transfer material is highly recommended.

IMPORTANT INFORMATION AND PRECAUTIONS



The MicroOSLON's LED, when powered up, is very bright. Thus it is advised that you do not look directly at it. Turn the PowerStar away from you and do not shine into the eyes of others.



MicroOSLONs, when operated, can reach high temperatures thus there is risk of injury if they are touched.



MicroOSLONs will overheat in operation if not attached to a suitable heatsink. Overheating can cause failure or irreparable damage.



DO NOT HOT PLUG ON LED SIDE OF POWER SUPPLY.



Do not operate MicroOSLONs with a power supply with unlimited current. Connection to constant voltage power supplies that are not current limited may cause the MicroOSLON to consume current above the specified maximum and cause failure or irreparable damage.



DO NOT TOUCH or PUSH on the LED as this can cause irreparable damage.

SAFETY INFORMATION



The MicroOSLON itself and all its components must not be mechanically stressed.



Assembly must not damage or destroy conducting paths on the circuit board.



The mounting of the module is carried out by attaching it at the mounting holes. Metal mounting screws must be insulated with synthetic washers to prevent circuit board damage and possible short circuiting.



To avoid mechanical damage to the connecting cables, the boards should be attached securely to the intended substrate. Heavy vibration should be avoided.



Observe correct polarity! Depending on the product, incorrect polarity will lead to emission of red or no light. The module can be destroyed!



Pay attention to standard ESD precautions when installing the MicroOSLONs.



The MicroOSLONs, as manufactured, have no conformal coating and therefore offer no inherent protection against corrosion. Damage by corrosion will not be accepted as a materials defect claim. It is the user's responsibility to provide suitable protection against corrosive agents such as moisture and condensation and other harmful elements.



For outdoor usage, a housing is definitely required to protect the board against environmental influences. The design of the housing must correspond to the IP standards in the application. It is also the responsibility of the user to ensure any housings or modifications keep the T_c junction temperature to within stated ranges.



To also ease the luminaire/installation approval, electronic control gear for LED or LED modules should carry the CE mark and be ENEC certified. In Europe the declarations of conformity must include the following standards: CE: EC 61374-2-13, EN 55015, IEC 61547 and IEC 61000-3-2 - ENEC: 61374-2-13 and IEC/EN 62384.



The evaluation of eye safety occurs according to the standard IEC 62471:2006 ("photobiological safety of lamps and lamp systems"). Within the risk grouping system of this CIE standard, the LED specified in this datasheet falls into the class "moderate risk" (exposure time 0.25s). Under real circumstances (for exposure time, eye pupils, observation distance), it is assumed that no endangerment to the eye exists from these devices. As a matter of principle, however, it should be mentioned that intense light sources have a high secondary exposure potential due to their blinding effect. As is also true when viewing other bright light sources (e.g. headlights), temporary reduction in visual acuity and afterimages can occur, leading to irritation, annoyance, visual impairment and even accidents, depending on the situation.

FURTHER INFORMATION

The values contained in this datasheet can change due to technical innovation. Any such changes will be made without separate notification.

If you require further assistance or have a specific or custom enquiry, please contact the ILS team via email or phone. Alternatively please visit our website for more product info and to see our full ranges.



Unit 2, Berkshire Business Centre,
Berkshire Drive, Thatcham,
Berkshire, RG19 4EW
+44 (0)1635 294606

info@i-led.co.uk

<https://i-led.co.uk>

ABOUT ILS

ILS offers a high level of technical skill, professionalism and commercial understanding to companies requiring market-leading optoelectronics solutions. Offering conceptual advice, electronics design and manufacturing capability, we use high quality production resources both in-house and in Asia, providing project support from prototyping to mass production. We also understand the need to provide cost-effective solutions and we do so using high quality components to ensure that the end product's reliability and quality is uncompromised. Apart from LEDs in the visible spectrum, we have a wide range of **Infrared**, **UV LEDs**, **UV tubes**, and lasers.

ILS is a division of **Intelligent Group Solutions Ltd (IGS)** a well-established respected industry leading Optoelectronics solutions provider. Much of IGS' business comes from providing semi-custom or custom products both in component and sub-assembly form, and from providing design support and prototyping within the European market place. We can deliver production displays to wherever in the world that the customer's manufacturing or assembly is being undertaken.

INTELLIGENT GROUP SOLUTIONS DIVISIONS

