

# N3535 1 PowerStar UV

## ILH-Xx01-Sxxx-SC211-WIR200 Series

### Product Overview

At the heart of each UV PowerStar product is a compact, high quality and reliable TSLC N3535 1-chip UV LED, with primary 55 or 125 degree lens, featuring high radiometric power density and design flexibility. The UV PowerStar range is suited to demanding industrial applications and features a vertical chip structure on a patented metal alloy substrate, offering advances in optical output and high thermal conductivity. PowerStars are compact, powerful LED light sources built on aluminium substrates for optimal thermal management. Available with 200mm wires as standard.

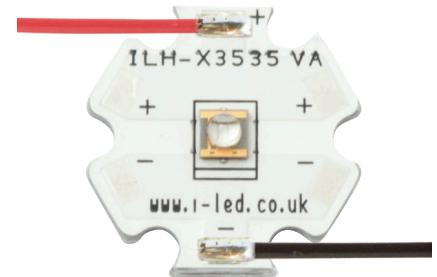

### Applications

- Polymer Curing
- Ink Curing
- Counterfeit Detection
- Aquarium Lighting
- Medical and DNA Sequencing
- Inspection Equipment
- Horticultural Lighting

### Technical Features

- N3535 1 PowerStar contains a 1-chip UV LED with integral 55 or 125 degree silicon lens
- Mounting holes using M3 screws allows easy installation
- Size (L x W x H) : 20mm x 20mm x 2mm
- Available with 200mm connecting wires
- Suitable Heat Sinks available – check options in Heat Sink section
- Matching Power Supply available - check options in Power Supply section
- PowerStars can be linked together to produce longer chains
- Current up to to 1000mA

\*This datasheet should be read in conjunction with the relevant TSLC data on the LED used

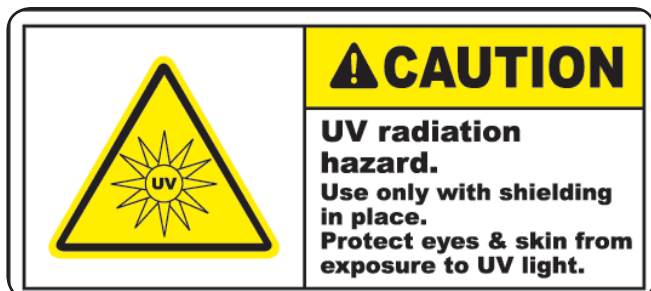

These products generate UVC radiation which can cause skin damage and conjunctivitis to humans and animals within a short time. The skin and eyes must be fully protected against exposure. You should be aware that UVC radiation does not eliminate harmful non-degradable substances such as heavy metals or pesticides. Assume IEC62471 Risk Group 3

### Important Information and Precautions

- The PowerStar's LED, when powered up, is very bright. Thus it is advised that you do not look directly at it. Turn the PowerStar away from you and do not shine into the eyes of others.
- These devices emit high intensity UV/NUV light. Necessary precautions must be taken during operation. Do not look directly into the light or look through the optical system when in operation. Protective eyewear should be worn at all times during operation.
- Lens discolouration may occur with prolonged exposure to UV/NUV light. Lens material will need to be tested for UV/NUV light compatibility and durability.
- PowerStars will overheat in operation if not attached to a suitable Heat Sink. Overheating can cause failure or irreparable damage.
- Do not operate PowerStars with a Power Supply with unlimited current. Connection to constant voltage Power Supplies that are not current limited may cause the PowerStar to consume current above the specified maximum and cause failure or irreparable damage.
- PowerStars, when operated, can reach high temperatures thus there is risk of injury if they are touched.
- DO NOT HOT PLUG ON LED SIDE OF POWER SUPPLY.
- DO NOT TOUCH or PUSH on the LED as this can cause irreparable damage.

### Product Options

ILS PART NUMBER	Peak Wavelength*		Typical Wattage at 350mA	Forward Voltage*	Minimum Radiometric Power (mW) at 350mA*	Radiance Angle	Relevant TSLC led data
	min λp	max λp					
ILH-XN01-S380-SC211-WIR200.	380nm	390nm	1.05	3-4V	320mW	55° (±27.5°)	N3535U-UNx1
ILH-XN01-S390-SC211-WIR200.	390nm	400nm	1.05	3-4V	360mW	55° (±27.5°)	N3535U-UNx1
ILH-XN01-S400-SC211-WIR200.	400nm	410nm	1.05	3-4V	400mW	55° (±27.5°)	N3535U-UNx1
ILH-XN01-S410-SC211-WIR200.	410nm	420nm	1.05	3-4V	400mW	55° (±27.5°)	N3535U-UNx1
ILH-XO01-S380-SC211-WIR200.	380nm	39nm	1.05	3-4V	320mW	125° (±62.5°)	N3535U-UNx1
ILH-XO01-S390-SC211-WIR200.	390nm	400nm	1.05	3-4V	360mW	125° (±62.5°)	N3535U-UNx1
ILH-XO01-S400-SC211-WIR200.	400nm	410nm	1.05	3-4V	400mW	125° (±62.5°)	N3535U-UNx1
ILH-XO01-S410-SC211-WIR200.	410nm	420nm	1.05	3-4V	400mW	125° (±62.5°)	N3535U-UNx1

\*Radiometric power is measured with an accuracy of ±10%.

\*The forward voltage is measured with an accuracy of ±0.2V

\*The peak/dominant wavelength is measured with an accuracy of ±1nm

### Minimum and Maximum Ratings

ILS PART NUMBER	Operating Temperature at Tc-Point [°C]*	Storage Temperature [°C]*	Forward Current per chip [mA]*	Reverse Voltage [Vdc]*
ILH-XN01-S380-SC211-WIR200.	70°C max	-40°C ~ 125°C	1000mA max	Not designed to be driven in reverse bias
ILH-XN01-S390-SC211-WIR200.	70°C max	-40°C ~ 125°C	1000mA max	Not designed to be driven in reverse bias
ILH-XN01-S400-SC211-WIR200.	70°C max	-40°C ~ 125°C	1000mA max	Not designed to be driven in reverse bias
ILH-XN01-S410-SC211-WIR200.	70°C max	-40°C ~ 125°C	1000mA max	Not designed to be driven in reverse bias
ILH-XO01-S380-SC211-WIR200.	70°C max	-40°C ~ 125°C	1000mA max	Not designed to be driven in reverse bias
ILH-XO01-S390-SC211-WIR200.	70°C max	-40°C ~ 125°C	1000mA max	Not designed to be driven in reverse bias
ILH-XO01-S400-SC211-WIR200.	70°C max	-40°C ~ 125°C	1000mA max	Not designed to be driven in reverse bias
ILH-XO01-S410-SC211-WIR200.	70°C max	-40°C ~ 125°C	1000mA max	Not designed to be driven in reverse bias

\* Exceeding maximum ratings for operating and storage temperature will reduce expected life time or destroy the LED module. Exceeding maximum ratings for operating voltage will cause hazardous overload and will likely destroy the LED module. The temperature of the LED module must be measured at the Tc-Point according to EN60598-1 in a thermally constant status with a temperature sensor or a temperature sensitive label.

### Radiation of single LED

Radiation Diagram for all "XN" product

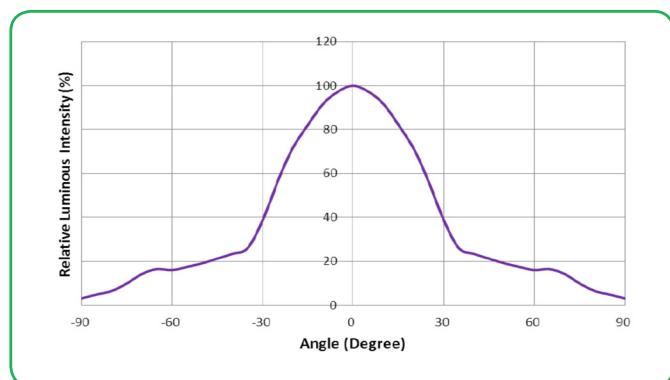

Radiation Diagram for all "XO" product

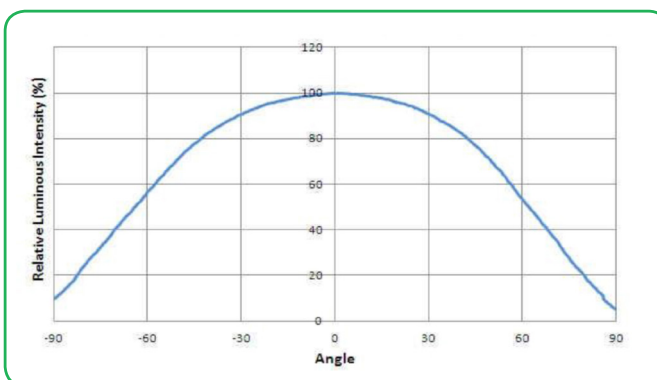

## Technical Drawing

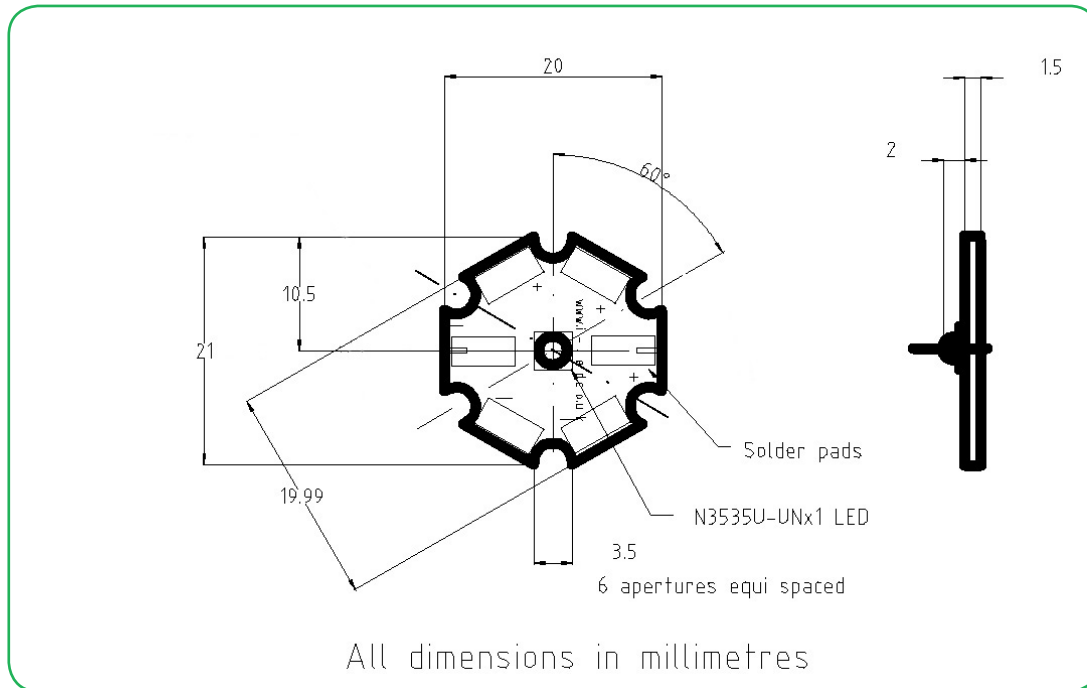

**3D drawing files are available on request from ILS. Please call or email**

## Lens and Reflector Options

LEDIL precision-engineered Lenses and Reflectors allow for rapid deployment of all types of light fixtures, including street lights, wall-wash, high-bay, sconces, emergency beacons, parking garage/low-bay, MR and AR down lights, and dock lights. Precision-engineered for maximum efficiency and durability, LEDIL Lenses and Reflectors are released alongside the latest product releases from our LED suppliers. You select the best LED for the application; choose LEDIL and you're selecting the best optical solution as well.



No Lenses or Reflectors for this product are available at the current moment. When lenses do become available for this board we will update this datasheet.

### Heat Sink Options

ILS has introduced a series of Aluminium Alloy Heat Sinks to be used with our standard range of PowerStars and PowerClusters. These Heat Sinks are supplied with fixing screws for the light engine and for fixing to a base plate. They also come with Thermal Interface Material (TIM) attached to the top surface. More versions will be introduced over the coming months and we are happy to manufacture custom Heat Sinks to your request.

	Operates under the recommended ILS junction temperature
	Operates under the recommended LED maximum junction temperature
	Not suitable for use
N/A	Heat Sink not designed for use with this product

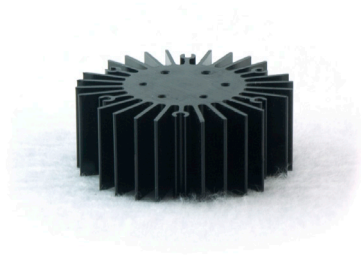

ILS Product		No Heat Sink, in free air	ILA-HSINK-STAR-50X20MM.	ILA-HSINK-STAR-50X40MM.	ILA-HSINK-STAR-50X60MM.	ILA-HSINK-STAR-50X80MM.	ILA-HSINK-CLUSTER-70X70X55MM.	ILA-HSINK-CLUSTER-78X46X25MM.
N3535 1 PowerStar UV	350mA							
	500mA							
	700mA							





## Power Supply Options

ILS has a comprehensive range of standard Power Supplies. The table below shows the total number of ILS products each Power Supply can drive.

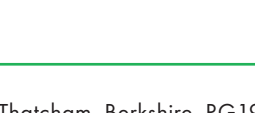
Additional Power Supplies are being introduced so please call us or check our website for the latest offering.

ILS Driver Part No.	Rating	Current	N3535 1 PowerStar	
IZC035-004F-4065C-SAL	4W	350mA	1-4	
IZC070-004F-4065C-SAL	4W	700mA	1	
IZC035-008F-5065C-SA	8W	350 mA	1-12	
IZC070-008F-5065C-SA	8W	700 mA	1-4	
IZC035-017F-0067A-SA	17W	350 mA	2-16	
IZC035-018T-9500A-SA	18W	350 mA dim	5-17	
IZC050-018T-9500A-SA	18W	500 mA dim	3-12	
IZC070-018T-9500A-SA	18W	700 mA dim	2-8	
IZC035-035F-9067C-QA	35W	350mA	13-26	
IZC070-035F-0067C-SA	35W	700 mA	3-16	
IZC045-040A-9266C-SA	40W	450 mA dim	10-29	
IZC070-050A-9267C-SA	50W	700 mA dim	8-24	

ILS Driver Part No.	Rating	Current	N3535 1 PowerStar	
IZC050-060F-9067C-QA	60W	500 mA	13-36	
IZC070-075A-9267C-SA	75W	700 mA dim	18-36	

### Thermal Interface Material Options

ILS have produced a range of high-performance, cost effective Thermal Interface Materials to match perfectly their standard products.

Our product fills the air pockets between the two surfaces, forming a continuous layer to conduct heat away from the LED to the Heat Sink.

ILS offer our TIM in three options – Double Sided Adhesive, Single Sided Adhesive and Non-Adhesive.

Product	Non Adhesive	Single Sided Adhesive	Double Sided Adhesive
Star	ILA-TIM-STAR-0A	ILA-TIM-STAR-1A	ILA-TIM-STAR-2A

Other sizes are available, including customised parts

### Assembly Information

- The mounting of the PowerStar has to be on a metal Heat Sink.
- In order to optimise the thermal management, the metal surface needs to be clean (dirt and oil free) and planar for the best contact with the LED module. A thermal grease or heat transfer material is highly recommended.

### Safety Information

- The LED module itself and all its components must not be mechanically stressed.
- Assembly must not damage or destroy conducting paths on the circuit board.
- The mounting of the module is carried out by attaching it at the mounting holes. Metal mounting screws must be insulated with synthetic washers to prevent circuit board damage and possible short circuiting.
- To avoid mechanical damage to the connecting cables, the boards should be attached securely to the intended substrate. Heavy vibration should be avoided.
- Observe correct polarity!
- Depending on the product, incorrect polarity will lead to emission of red or no light. The module can be destroyed!
- Pay attention to standard ESD precautions when installing the PowerStars.
- The PowerStars, as manufactured, have no conformal coating and therefore offer no inherent protection against corrosion.
- Damage by corrosion will not be accepted as a materials defect claim. It is the users responsibility to provide suitable protection against corrosive agents such as moisture and condensation and other harmful elements.
- For outdoor usage, a housing is definitely required to protect the board against environmental influences. The design of the housing must correspond to the IP standards in the application. It is also the responsibility of the user to ensure any housings or modifications keep the Tc junction temperature to within stated ranges.



- To also ease the luminaire/installation approval, electronic control gear for LED or LED modules should carry the CE mark and be ENEC certified. In Europe the declarations of conformity must include the following standards: CE: EC 61374-2-13, EN 55015, IEC 61547 and IEC 61000-3-2 - ENEC: 61374-2-13 and IEC/EN 62384.
- The evaluation of eye safety occurs according to the standard IEC 62471:2006 ("photobiological safety of lamps and lamp systems"). Within the risk grouping system of this CIE standard, the LED specified in this data sheet falls into the class "moderate risk" (exposure time 0.25s). Under real circumstances (for exposure time, eye pupils, observation distance), it is assumed that no endangerment to the eye exists from these devices. As a matter of principle, however, it should be mentioned that intense light sources have a high secondary exposure potential due to their blinding effect. As is also true when viewing other bright light sources (e.g. headlights), temporary reduction in visual acuity and afterimages can occur, leading to irritation, annoyance, visual impairment and even accidents, depending on the situation.

## For further information please contact ILS

The values contained in this data sheet can change due to technical innovations. Any such changes will be made without separate notification.