

ILS Programmable 4 Channel LED Driver

ILA-4CHANNEL-LED-TUNER-001.

Product Overview

ILS have developed a driver to help in the development of Tuneable White and RGBW multi-LED products, or any system that requires up to 4 channels of controllable LED driving.

Each of the 4 channels can deliver 20v at a maximum drive current of 999mA

The ILA-4CHANNEL-LED-TUNER-001. has 2 modes of active operation;

- Programmed mode
- Standalone mode

Standalone mode gives you full control over all 4 channels, you can set the currents of all 4 channels individually. This makes setting up specific shades of white or colours easy, as they can be adjusted by simply using the buttons on the PCB.

Programmed mode allows you to create a sequence of different settings for each channel with down to 100ms intervals. This allows the system to ramp up, ramp down, fade from one colour to another etc... This is all created in excel and is imported into the ILA-4CHANNEL-LED-TUNER-001. via a USB memory stick. Multiple profiles can be stored onto the USB key, and then viewed and selected via the on-board LCD.

The ILA-4CHANNEL-LED-TUNER-001. Is aimed as a development tool to make driving complex LED systems easy, for a proof of concept or evaluation.

Technical Features

- 4 independent 999mA, 20v channels
- 128x64 LCD for easy control
- Compact 140mm x 155mm desktop unit
- User upgradeable to be able to drive all future ILS products
- Simple press-fit output connectors
- Requires a 24v DC external power supply
- Easy to use multi coloured Display
- Easily create scenes such as sunrise or white colour sweep

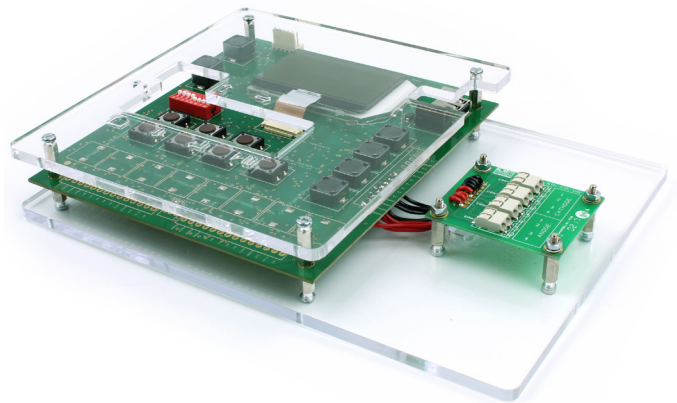

Important Information and Precautions

- The LEDs, when powered up, are very bright. Thus it is advised that you do not look directly at them. All LED product must be turned away from you and do not shine into the eyes of others.
- LEDs will overheat in operation if not attached to a suitable Heat Sink using a suitable thermal interface material. Overheating can cause failure or damage.
- Do not operate LED products with a Power Supply with unlimited current. Connection to constant voltage supplies that are not current limited may cause the LED product to consume current above the specified maximum and cause failure or irreparable damage.
- LED products, when operated, can reach high temperatures thus there is risk of injury if they are touched.
- The LEDs, when powered up not visible to the naked eye. Thus it is advised that you do not look directly at it. Turn the LED away from you and do not shine into the eyes of others.
- DO NOT HOT PLUG ON LED SIDE OF POWER SUPPLY

Product Options

ILS PART NUMBER	Input Voltage
ILA-4CHANNEL-LED-TUNER-001.	ILS Programmable 4 channel LED power supply

Technical Drawing with cables (mm)

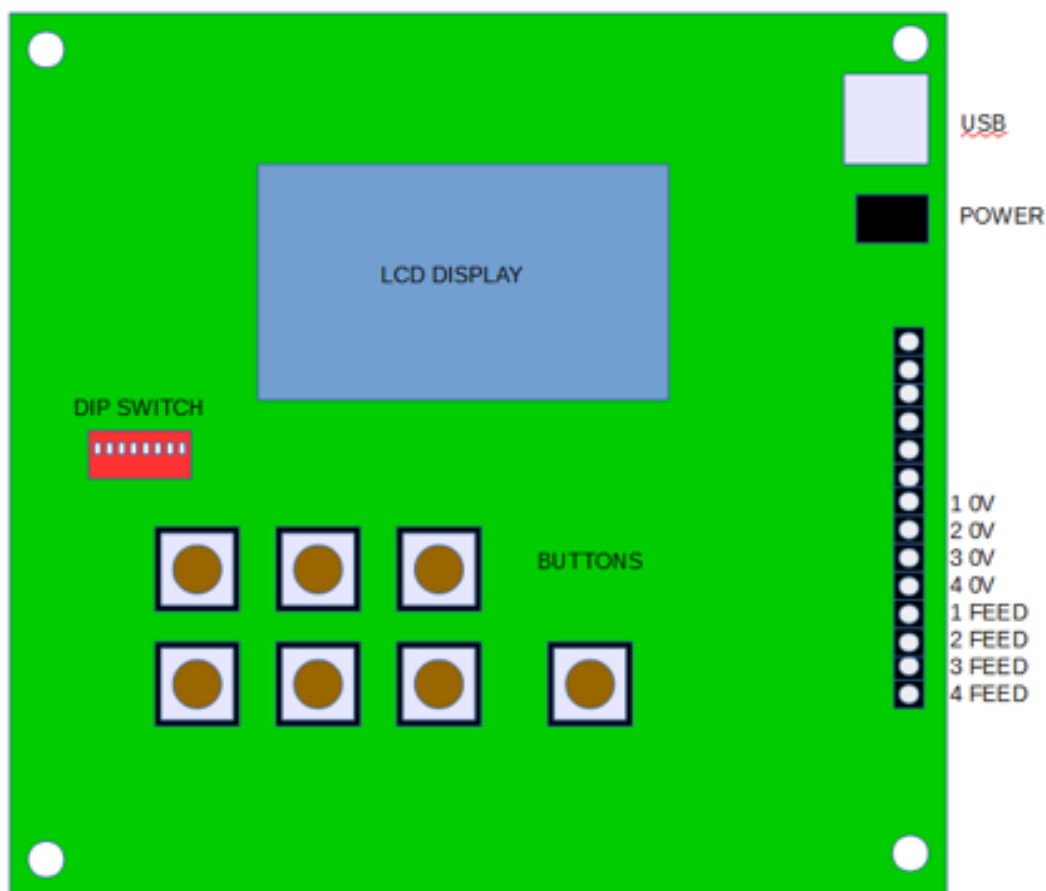

DXF Drawing files are available on request from ILS. Please call or email

LCD Display

The 128x64 RGB backlit display is the way we control the various features of the ILA-4CHANNEL-LED-TUNER-001.

The screen layout changes depending on which mode you are in, also the backlight changes colour to help show you which mode you are in.

Colour	Mode
White	Boot mode
Blue	USB mode - Initialising
Purple	USB mode
Yellow	Standalone mode
Green	LED drives are turned on



USB Input Connector

This socket is used for the USB Memory stick. The USB stick is used in program mode to contain the sequences. The USB stick is also used to update the system firmware.

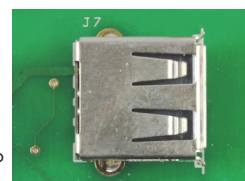

Mode Selection Switch

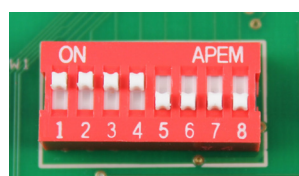

These dip switches select one of the 3 modes the ILA-4CHANNEL-LED-TUNER-001. is operating in.

Mode	DIP Switch Setting
Standalone	1-4 ON, 5-8 OFF
Program mode	1-4 OFF, 5-8 ON
Firmware Update	1-8 ON

Control Buttons

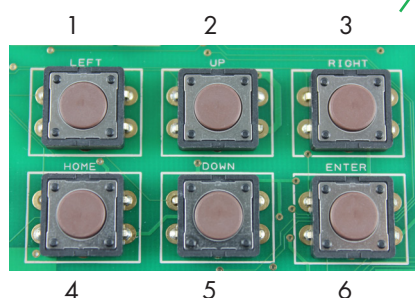

These 6 buttons are used to set the various modes and conditions. All controls are via the main LCD and these buttons control the cursor on the screen.

No.	Button	Function
1	LEFT	Moves the cursor to the left
2	RIGHT	Moves the cursor to the right
3	UP	Moves the cursor up a line
4	DOWN	Moves the cursor down a line
5	HOME	Takes you back to the initial screen
6	ENTER	Selects a menu item

LED output ON / PAUSE button

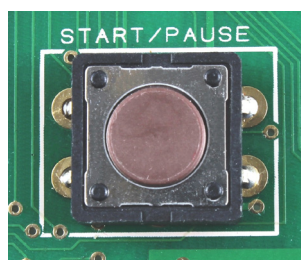

Pressing this button turns the LED drive circuits ON. Pressing it again pauses the current LED control, allowing for finer tweaking of the output profile. Another press re-energises the LED output drivers, but using these new tweaked values.

Power Connector

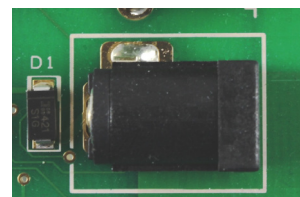

Please use upto +24Vdc , 3 Amp, centre positive 2.1mm jack, Recommended power supplies are listed in the power supply section This is the maximum requirement of the ILS-ILA-4CHANNEL-LED-TUNER-001., enabling 4 chains of 4 LEDs per chain to be controlled. If you are driving a smaller number of LEDs per chain, then a lower specification power supply may be used.

Connector

This is where you connect the LEDs to the driver. (* note below) Pin 1 is at the top near the power connector. These connections are available on the press fit adapter board



PIN	Marking	Function
1	0V	Not currently used
2	3.3V	Not currently used
3	CLK	Not currently used
4	ALERT	Not currently used
5	DATA	Not currently used
6	NC	Not currently used
7	0V	LED Load 1 Cathode -VE
8	0V	LED Load 2 Cathode -VE
9	0V	LED Load 3 Cathode -VE
10	0V	LED Load 4 Cathode -VE
11	FEED 1	LED Load 1 Anode +VE
12	FEED 2	LED Load 1 Anode +VE
13	FEED 3	LED Load 1 Anode +VE
14	FEED 4	LED Load 1 Anode +VE

* These connections are taken to a separate PCB to allow easier access

Choice of power supply

The unit will work on a wide range of power supplies, however the following must be taken into account.

- The DC voltage of the power supply must be at least 6 Volts above the LED string voltage to allow the drivers to operate correctly
- The power rating must be at least the power rating of the LED strings at required load plus 30%
- The power supply must be higher than 9V

Precautions

- Voltages higher than 24V may cause permanent damage
- Reverse polarity may cause permanent damage

Power Input	Min	Max	Units
Input voltage	9.0	24.0	V DC
Input Current	0.025	3	A DC
Input Power	1	75	W

The following power supplies are recommended

Power Supply Description	RS part number
24V 3A	904-8503
24V 2.5A	125-4248
24V 1A	436-058
12V 3A	904-8486
12V 1A	828-0074

How to connect your LEDs to the power supply

Choice of LED clusters

The unit has been developed with Osram Oslon LEDs, and these are the recommended LED. They are available in many different colours and beam angles. Please contact info@i-led.co.uk for support, or refer to individual datasheets for specific details.

The following range of LED clusters are recommended

Part Number	Description	RS
ILH-OW04-RGBW-PC211-WIR200.	4 LED Oslon Star RGBW 150 wired	875-0172
ILH-ON04-RGBW-PC211-WIR200.	4 LED Oslon Star RGBW 80 wired	875-0179
ILH-OW04-HWUL-PC221-WIR200.	4 LED OSLOON Tuneable White PowerStar Hot White + Ultra White	122-5175
ILH-OW04-HWNU-PC221-WIR200.	4 LED OSLOON Tuneable White PowerStar Hot White + Warm White + Neutral White + Ultra White	122-5176
ILR-OW09-HWNU-PC221-WIR200.	9 LED OSLOON Tuneable White PowerCluster Hot White + Quartz White + Neutral White	122-5177
ILR-OW09-HQUX-PC221-WIR200.	9 LED OSLOON Tuneable White PowerCluster Hot White, Quartz White, Ultra White	122-5178
ILR-OW16-HWUL-PC221-WIR200.	16 LED OSLOON Tuneable White PowerCluster Hot White + Ultra White	122-5179
ILR-OW16-HWNU-PC221-WIR200.	16 LED OSLOON Tuneable White PowerCluster Hot White + Warm White + Neutral White + Ultra White	122-5180

The following associated Heatsinks and mounting kits are recommended, Heatsink kits contain a Heatsink, thermal interface material(TIM) and screw kits.

Part Number	Description	RS
ILA-HSINK-STAR-50X20MM-BLK-K	LED Star Heatsink Kit 50x20mm Black Recommended for use with 4 LED PowerStars but not above 700mA	780-5893
ILA-HSINK-STAR-50X40MM-BLK-K	LED Star Heatsink Kit 50x40mm Black Recommended for use with 4 LED PowerStars but not above 1000mA	780-5919
ILA-HSINK-STAR-50X60MM-BLK-K	LED Star Heatsink Kit 50x60mm Black Recommended for use with 4 LED PowerStars but not above 1000mA	780-5928
ILA-HSINK-STAR-50X80MM-BLK-K	LED Star Heatsink Kit 50x80mm Black Recommended for use with 4 LED PowerStars but not above 1000mA	780-5938
ILA-HSINK-78X46X25MM-BLK-K	LED Cluster Heatsink Kit 78x46x25mm Black Recommended for use with the 9 LED PowerClusters	780-5962
ILA-HSINK-70X70X55MM-BLK-K	LED Cluster Heatsink Kit 70x70x55mm Black Recommend for use with the 16 LED PowerClusters	780-5953

Operational Limits and Measurement Accuracy

OUTPUT SECTION	Min	Max	Units
LED string voltage	2.0	16.0	V DC
LED string current	1 (note)	999	mA DC
LED strings operating	1	4	Channels

Note: Many LEDs have a minimum operating current – please review manufacturer’s datasheet.

Precautions	
Output Short circuit protection	Yes
Output Open circuit protection	The output terminals will rise to the input voltage
Driver thermal shut down	160 °C on driver die

This unit is a sequencing driver intended solely for use as part of a development system. As such the currents displayed on the LCD screen are for indication only and will differ from those taken from an electronic current meter.

The driver is capable of a range of currents from 1 to 999mA in 1mA steps which is a 0.1% incremental change. This differs from standard drivers which are optimised for a single current and are normally very accurate. At low levels, the displayed readings are below the noise threshold so will be inaccurate. Therefore if you need accurate readings, please add a multi-meter into your system.

Standalone Mode

This mode allows the user to enter currents for each channel individually using the buttons on the front of the unit. The “Start / Pause” button is then used to activate the driver. In this mode, there is only 1 current per channel, and will remain at that current until the “Start / Pause” button is pressed again. The current can be changed at any time by stopping the driver and entering fresh values. This allows fast tweaking of the currents to achieve the desired colour or intensity lighting.

Typical applications:

- Testing individual LEDs at specific currents
- Testing a colour mix from multiple LEDs
- Driving LEDs to allow thermal testing
- Driving the currents required to achieve a specific colour from RGBW LEDs
- Driving the currents required to achieve a specific colour temperature from Tuneable White LEDs

Parameter	Min	Max	Unit
Channel Current	0	999	mA (Note)
Number of active channels	1	4	Channels

Further details on the manual mode can be obtained in our getting started guides

USB Mode

This mode allows the user to create a lighting sequence in Microsoft Excel and then transfer the data to the driver via a flash-disk. The sequence comprises a list of rows with each row containing the currents for each of the 4 channels and a time interval. The rows are repeated to add to the sequence. At the end of the sequence, the driver starts back at line 1 and continues. Multiple files can be stored on the flash-disk and can be accessed via the LCD menu.

Typical applications

- Colour rolling with RGBW LEDs
- Colour temperature rolling with Tunable White LEDs
- 4 channel sequenced lighting display prototyping
- 4 channel signage back lighting prototyping
- POS display prototyping
- Trade stand lighting

Sequence Parameter	Min	Max	Unit
Channel Current	0	999	mA (Note 1)
Number of active channels	1	4	Channels
Number of steps in sequence	1	10,000	Steps
Step interval time	0.1	9,999.9	Seconds
Number of files on flash-disk	1	100	Files
File name characters	1	8	Characters (Note 2)
Flash disk size	2GB	64GB	Mb (Note 3)

Notes:

1. The currents must be an integer. If numbers with decimal places are used, an error message will be displayed.
2. This is limited to 8 characters by the core library function. If longer file names are used these will be truncated on the LCD and will end in :1, :2, :3 etc...
3. The flash disk should be formatted to FAT however some flash disks are OK with FAT32.

Further details on the USB mode can be obtained in our getting started guides.

Safety Information

- The LED module itself and all its components must not be mechanically stressed.
- Assembly must not damage or destroy conducting paths on the circuit board.
- The mounting of the module is carried out by attaching it at the mounting holes. Metal mounting screws must be insulated with synthetic washers to prevent circuit board damage and possible short circuiting.
- To avoid mechanical damage to the connecting cables, the boards should be attached securely to the intended substrate. Heavy vibration should be avoided.
- Observe correct polarity!
- Depending on the product, incorrect polarity will lead to emission of red or no light. The module can be destroyed!
- Pay attention to standard ESD precautions when installing the LEDs.
- The LED, as manufactured, have no conformal coating and therefore offer no inherent protection against corrosion.
- Damage by corrosion will not be accepted as a materials defect claim. It is the users responsibility to provide suitable protection against corrosive agents such as moisture and condensation and other harmful elements.
- For outdoor usage, a housing is definitely required to protect the board against environmental influences. The design of the housing must correspond to the IP standards in the application. It is also the responsibility of the user to ensure any housings or modifications keep the Tc junction temperature to within stated ranges.
- To also ease the luminaire/installation approval, electronic control gear for LED or LED modules should carry the CE mark and be ENEC certified. In Europe the declarations of conformity must include the following standards: CE: EC 61374-2-13, EN 55015, IEC 61547 and IEC 61000-3-2 - ENEC: 61374-2-13 and IEC/EN 62384.
- The evaluation of eye safety occurs according to the standard IEC 62471:2006 ("photobiological safety of lamps and lamp systems"). Within the risk grouping system of this CIE standard, the LED specified in this data sheet falls into the class "moderate risk" (exposure time 0.25s). Under real circumstances (for exposure time, eye pupils, observation distance), it is assumed that no endangerment to the eye exists from these devices. As a matter of principle, however, it should be mentioned that intense light sources have a high secondary exposure potential due to their blinding effect. As is also true when viewing other bright light sources (e.g. headlights), temporary reduction in visual acuity and afterimages can occur, leading to irritation, annoyance, visual impairment and even accidents, depending on the situation.

For further information please contact ILS

The values contained in this data sheet can change due to technical innovations. Any such changes will be made without separate notification.